

PREMIÈRE

design marconato&zappa

Première è un sistema di sedute ampio e componibile dal design personale e autorevole, caratterizzato da una comodità senza confronti. Première offre la possibilità di alzare e posizionare a proprio piacimento la parte alta dello schienale trasformandola in un comodo poggia-testa.

Première is a generously deep seating, modular system with a personal, leading design featuring unprecedented comfort. In fact, with Première you can raise and position the top part of the backrest how you like, turning it into a truly relaxing headrest.

Divano Première.
Première sofa.





Divano e pouff Première.
Première sofa and pouff.



RELAX SENZA CONFRONTI

Première è sicuramente un divano dalla comodità superiore grazie alla possibilità di alzare e posizionare la parte alta dello schienale ottenendo un confortevole poggiatesta.

The comfort of the Première sofa is without a doubt superior because it is possible to raise and position the top part of the backrest to obtain a relaxing headrest.

Divano Première e poltrone Moon.
Première sofa and Moon armchairs.



PREMIÈRE

design marconato&zappa

Caratteristiche: Una componibilità generosa grazie alla vasta gamma di elementi fissi e aggregabili. Première è sicuramente un divano dalla comodità superiore grazie alla possibilità di alzare e posizionare la parte alta dello schienale ottenendo un confortevole poggia-testa. Morbidi cuscini orizzontali poggia-reni completano la speciale dotazione di Première. Particolare ed esclusivo è il design del bracciolo.

A richiesta, cuscinatura sedute e poggia-reni possono essere realizzate in piuma d'oca con inserto in poliuretano. Première è completamente sfoderabile.

Struttura: 1_Structura in legno di abete. 2_Pannelli di legno compensato. 3_Pannelli di legno multistrati. 4_Molle ottenute con cinghie elastiche Elasmat 790/4 larghezza 90 mm.

Imbottitura della struttura: 5_Poliuretano espanso a densità differenziata TL25 - T40P - SR75. 6_Resinato 100 gr. accoppiato con vellutino.

Imbottitura dei cuscini: 7_Cuscini sedile in poliuretano espanso a densità differenziata WLD35 - OS30FM. 8_Termolegato 400 gr. con tela di cotone.

9_Cuscini schienali in poliuretano espanso a densità differenziata PF25SM - OS30FM - PF30M - T40F - MTP95. 10_Termolegato 300 gr. con tela di cotone. 11_Cuscinetto poggia-rieni in poliuretano espanso OS30FM.

12_Termolegato 400 gr. con tela di cotone.

Rivestimento: 13_Rivestimento in pelle o in tessuto completamente sfoderabile.

Finiture: 14_Piedini in faggio tinto.

Characteristics: Generous modular design thanks to the extensive range of fixed and compositional elements. The comfort of the Première sofa is without a doubt superior because it is possible to raise and position the top part of the backrest to obtain a relaxing headrest. Soft, horizontal lower back cushions complete the special fittings on Première. The armrest design is unusual and exclusive. On request, the seat and backrest cushions can be down-filled with polyurethane inner foam core. Première has fully removable covers.

Structure: 1_Pinewood frame. 2_Plywood panels. 3_Multilayer panels.

4_Suspension obtained from 90 mm wide, Elasmat 790/4 elastic belts.

Structure padding: 5_Differentiated density expanded polyurethane TL25 - T40P - SR75. 6_Resin 100 gr. coupled with velveteen.

Cushions padding: 7_Seat cushions in differentiated density expanded polyurethane: WLD35 - OS30FM. 8_Heat bonded with 400 gr. cotton cover.

9_Backrest cushions in differentiated density expanded polyurethane: PF25SM - OS30FM - PF30M - T40F - MTP95. 10_Heat bonded with 300 gr. cotton cover. 11_Loinrest in differentiated density expanded polyurethane OS30FM.

12_Heat bonded with 400 gr. cotton cover.

Cover: 13_Completely removable leather or fabric cover.

Finishing: 14_Feet in tinted beech-wood.

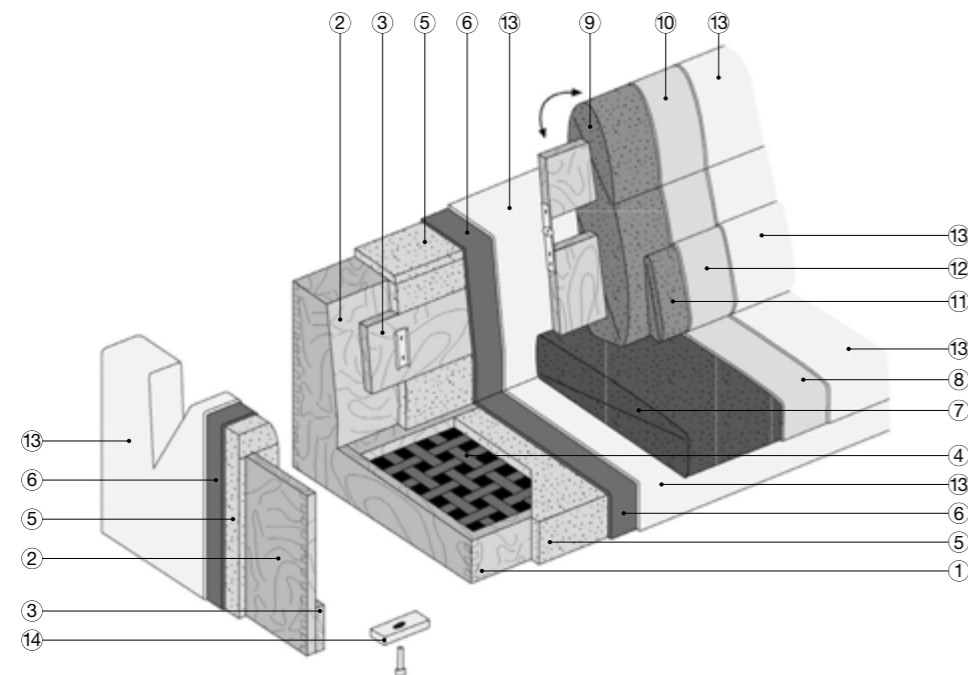
**Composizione pagine 56/57**

Divano Première: rivestimento pelle Nabuk 17

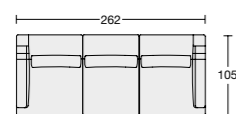
**Composizione pagine 58/59**

Divano Première: rivestimento 1310/05 cat. H
Pouf: rivestimento 1310/05 cat. H

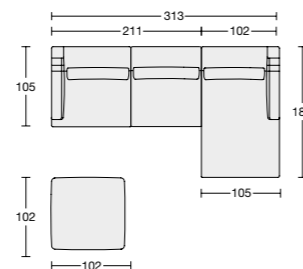
**Composizione pagine 60/61**

Divano Première: rivestimento 1300/11 cat. H
Poltrone Moon: rivestimento 1310/7 cat. H e basamento tinta wengè

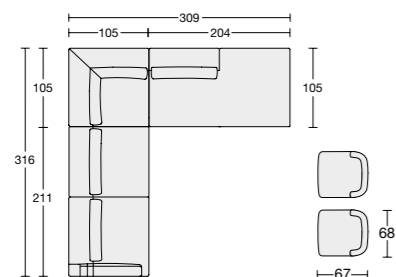

PREMIÈRE 676

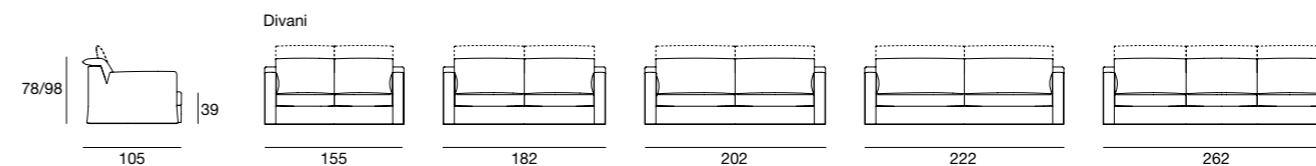

Poltrone bracciolo sx/dx

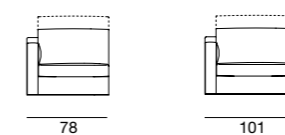

Divani bracciolo sx/dx

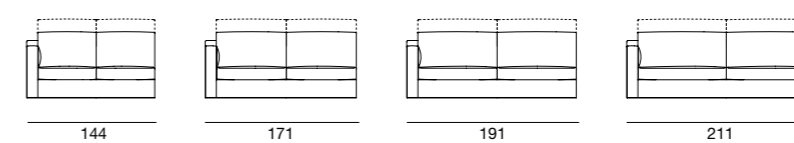

Poltrone centrali



Divani centrali

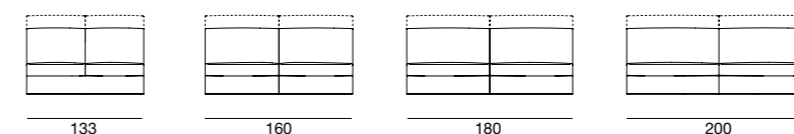

Penisola sx/dx

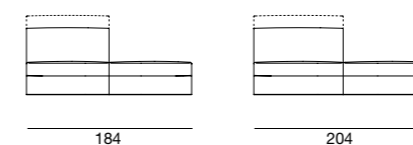

Chaise longue lunga sx/dx

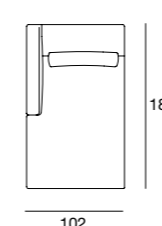

Angolo retto

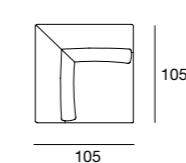

Pouff quadrato

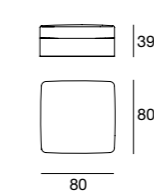

Pouff quadrato

